

KUFO/SECO DUST COLLECTOR

UFO-102B



3HP / 220V / 1PH /3PH /60HZ

- **Caution:** This Dust Collector is designed to Collect Wood Working Dusts only. Use of this product to remove any other types of dust will **VOID THE WARRANTY.** We offer other models of dust collectors to be used with more abrasive dusts and powders. Please, contact us @ 888-558-4628 for specific recommendations.
- **Caution:** The machine operator should carefully read and understand the owner's manual before operating this machine! Also, the manufacturer is not responsible for any damages or injuries caused by any modifications to machine
- **Caution:** Before you turn on the dust collector, please, make sure the motor is **Single Phase or Three Phase.**

KUFO/SECO DUST COLLECTOR

Connection diagram

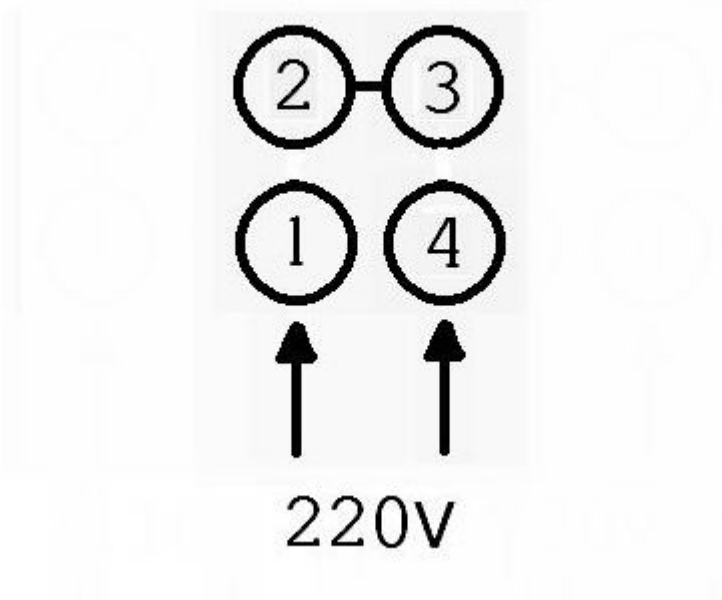

If your Dust Collector is 220V / Single Phase, please, read the following information carefully!

- **This Dust Collector is wired for 220V / Single Phase use only.**
- See the wiring diagram for the proper wiring voltage for your use. Please note: Be sure the **Ground Wire** is securely attached to the motor body for 220V wiring. Please Contact Us Toll Free @ 888-558-4628, if you need additional information, before starting the machine.
- **CAUTION:**
 1. Dust Collector UFO-101 use 220V only. UFO-101 does not have a dual voltage motor and cannot be run on 110 volt power.
 2. Dust Collector UFO-101 (UL) use 240V only. UFO-101 (UL) does not have a dual voltage motor and cannot be run on 110 volt power.
 3. The machine operator should carefully read and understand the owner's manual before operating this machine! Also, the manufacturer is not responsible for any damages or injuries caused by any modifications to machine

KUFO/SECO DUST COLLECTOR

Connection diagram

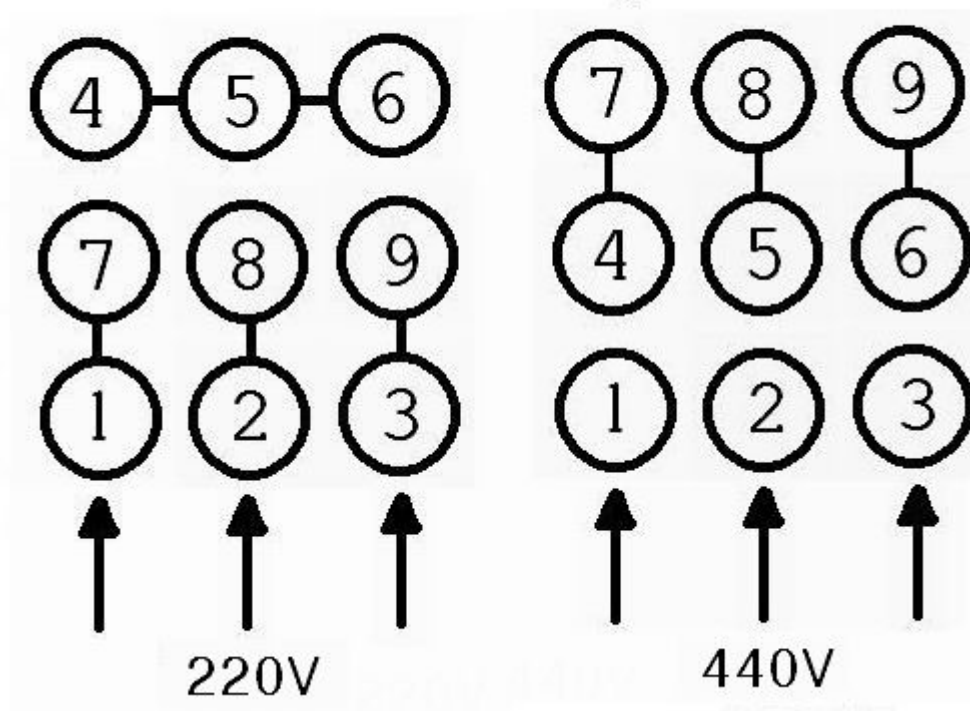

*** Wiring Instructions for 220V / 440V / three phase motor ***.

If your Dust Collector is three phase, please, read following information carefully!

- **This Dust Collector is Pre-wired for 220V / 3 Phase use.**
- See the wiring diagram for the proper wiring voltage for your use. Please note: Be sure the **Ground Wire** is securely attached to the motor body for either 220V or 440V wiring. Please Contact Us Toll Free @ 888-558-4628, if you need additional information, before starting the machine.
- **Caution:** The machine operator should carefully read and understand the owner's manual before operating this machine! Also, the manufacturer is not responsible for any damages or injuries caused by any modifications to machine

UFO-102B

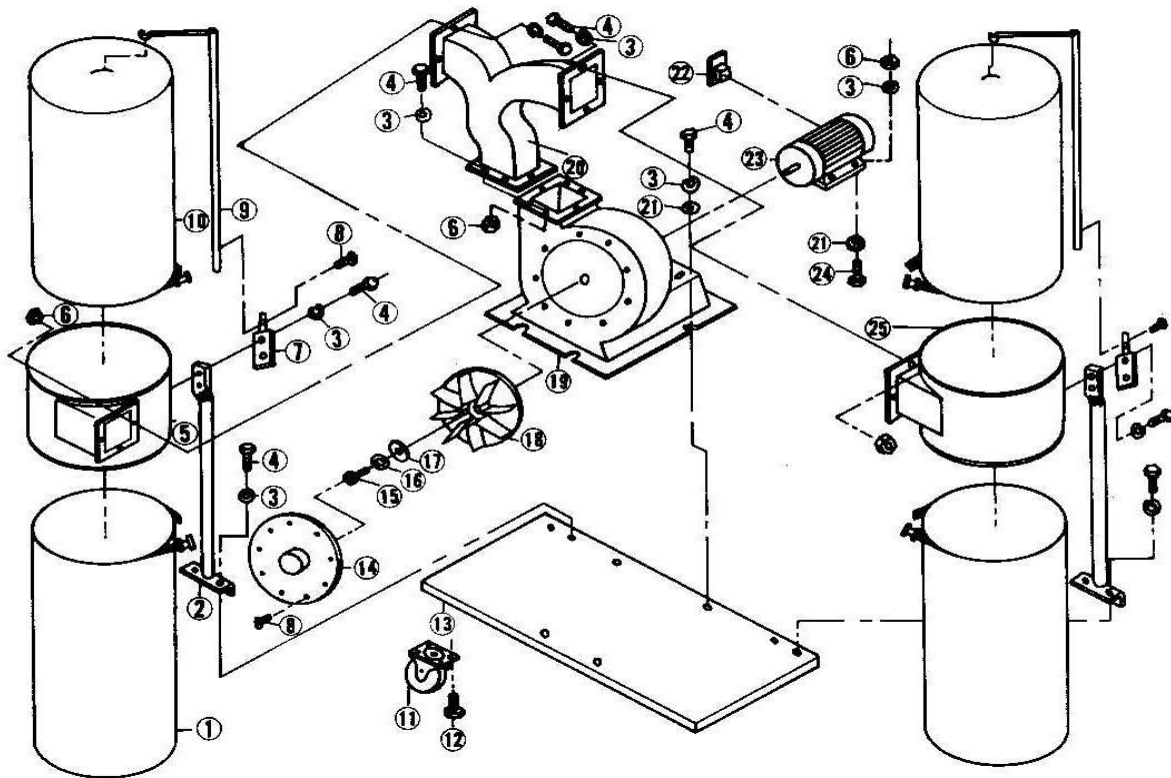

* PARTS LIST *

Part No.	Description	Size	Quantity
1.	Collection bag		2
2.	Support		2
3.	Spring washer		30
4.	Screw	5/16"x3/4"L	26
5.	Collector		1
6.	Nut	5/16"	18
7.	Support insert		2
8.	Screw	1/4"x3/8"L	14
9.	Bag support		2
10.	Filter bag		2
11.	Caster		4
12.	Screw	5/16"x1/2"L	16
13.	Base plate		1
14.	Inlet cover		1
15.	Screw	1/4"x3/4"L	1
16.	Spring washer		1
17.	Washer		1
18.	Fan with plate		1
19.	Collector body		1
20.	Connector		1
21.	Washer		8
22.	Switch		1
23.	Motor		1
24.	Screw	5/16"x1"L	4
25.	Collector		1
26.	Shutter		1

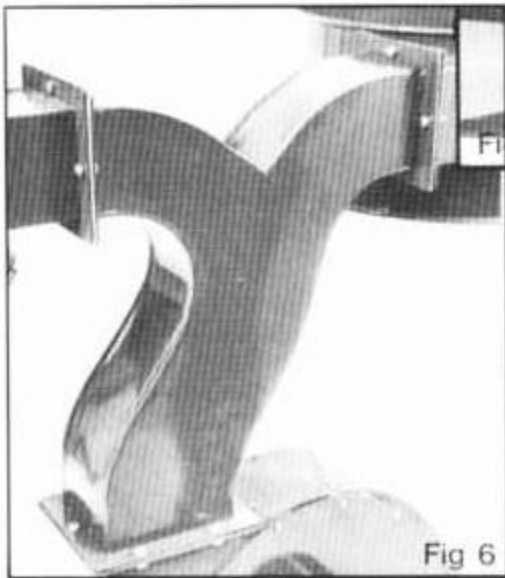

Fig 6



Fig 6 shows the two collectors attached to the connector and fan/motor assy.



Fig 7

Now install the two collector supports(H) and the two support inserts(G) as shown in fig 7 and fig 8.



Fig 8

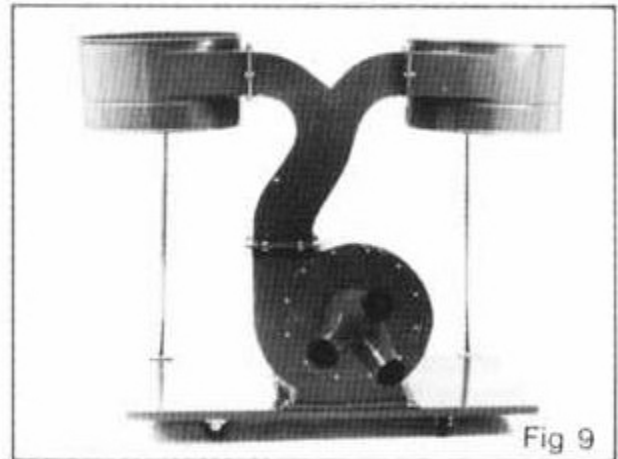

Fig 9



Fig 9 shows the Dust Collector as it should now appear.

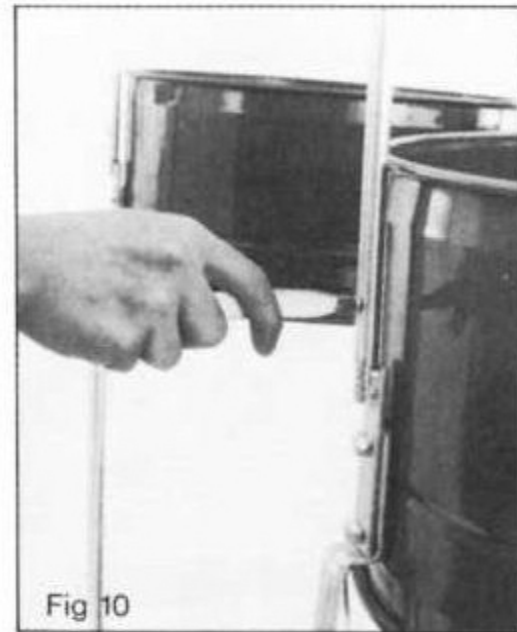

Fig 10



At this time the two bag supports(E) should be installed onto the support inserts as shown in fig 10.

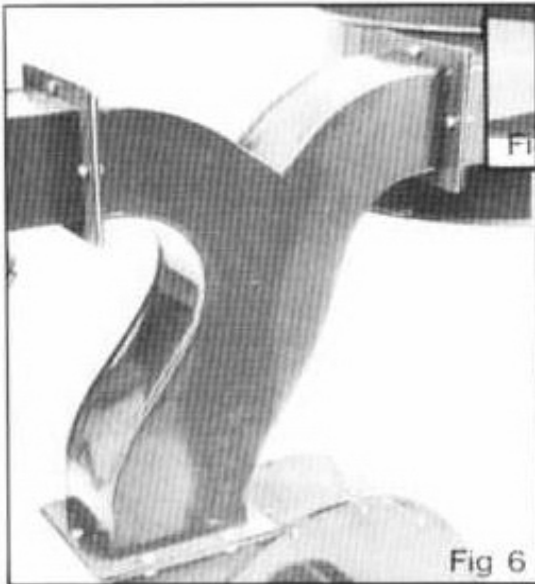

Fig 6 shows the two collectors attached to the connector and fan/motor assy.

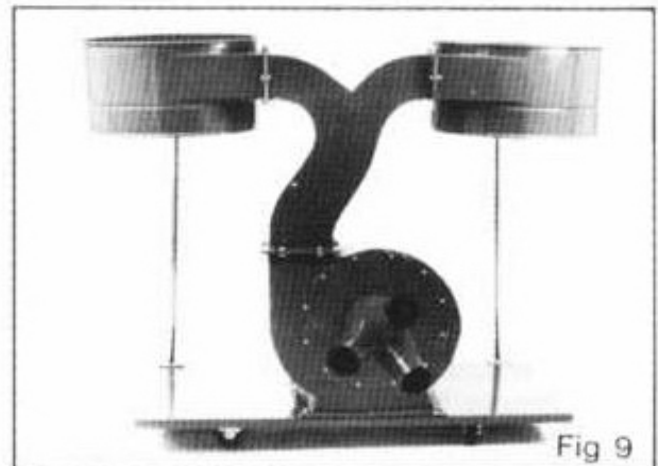

Fig 9 shows the Dust Collector as it should now appear.

Now install the two collector supports (H) and the two support inserts (G) as shown in fig 7 and fig 8.



At this time the two bag supports (E) should be installed onto the support inserts as shown in fig 10.

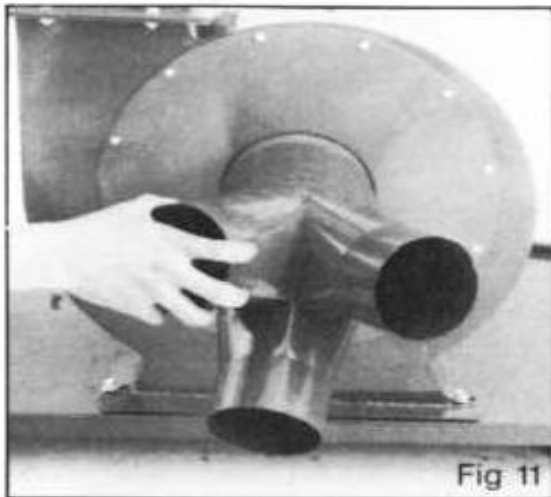

Fig 11



The shutter can now be placed on the intake hole of the fan/motor assy. Fig 11.

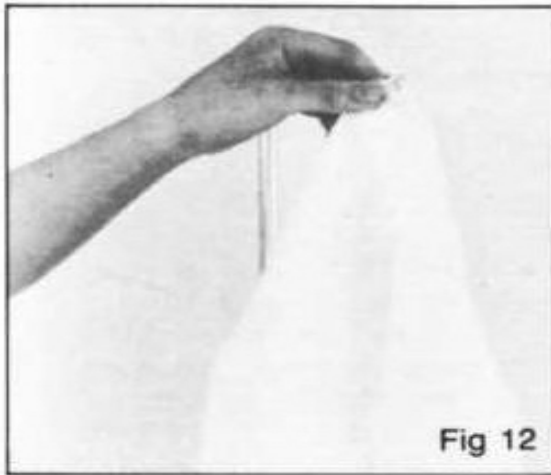

Fig 12

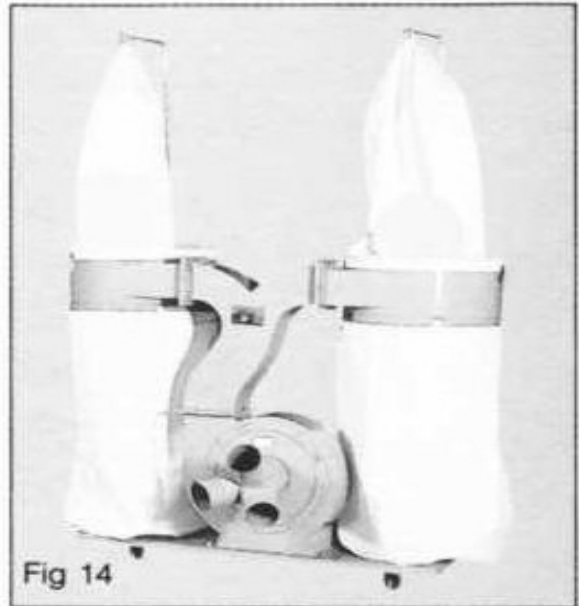

Fig 14



Your new Dust Collector should now look like the one pictured in fig 14.



Next, hang the two filter bags (D) from the support rods. Fig 12.

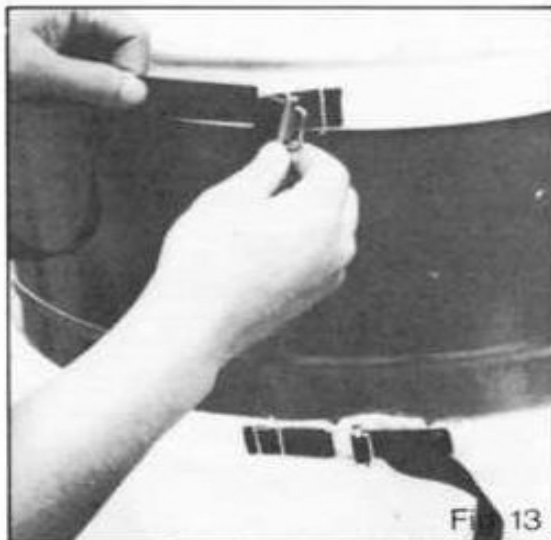

Fig 13



Now attach the two filter and two collection bags to the collectors using the bands sewn in the base of the bags as shown in fig 13.

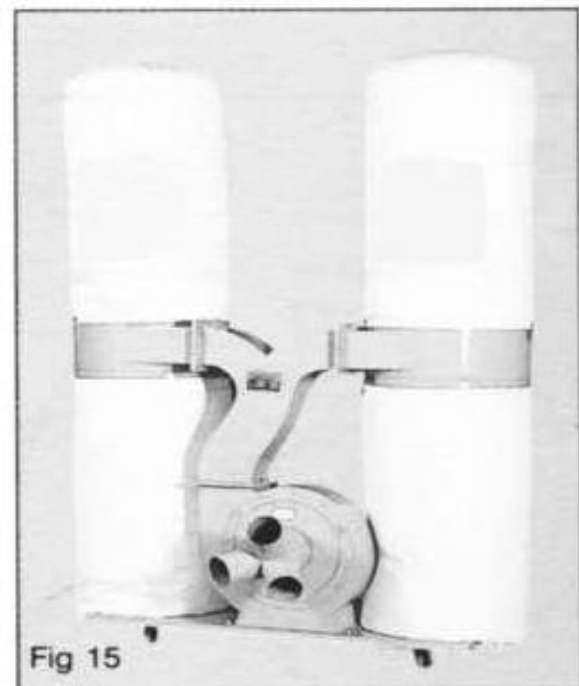

Fig 15



The Dust Collector is now ready to be placed into service. Before connecting to a power source, be sure the power source is properly grounded and is of proper voltage and amperage.